

Measurement and Evaluation of Ground Station Parameters for ISRO Launch Mission

Harshitha N¹, Kondapalli Sravani², Mamatha R Reddy³, Thejaswini P⁴

^{1,2,3}Department of Electronics and Communication, JSSATE, Bengaluru
mamathareddy1219@gmail.com

⁴Assistant Professor, Department of Electronics and Communication, JSSATE, Bangalore
thejukiran@gmail.com

Abstract—ISTRAC (ISRO telemetry, tracking and command network) is responsible for providing space operation services that include spacecraft control, telemetry, tracking and command (TTC) services. To qualify as a ground station, the characteristics of every system in the station is to be tested at regular interval of time in regarding its performance specification. The ground station acts as an interface between the satellite and satellite controllers by providing the services and functions namely telemetry, tracking and command collectively called as TTC operation .To carry out the above function effectively a ground station needs to be evaluated for its performance of critical parameters. The main objective of this work is to perform through test on the various systems that constitute the ground station such as the antenna system, receive system, uplink system ,servo control system, ranging & Doppler system, receive system and timing system .The results produced in these test are used to indicate the credibility of the ISTAC ground station.

Index Terms— Ground Station, TTCP, satellite, communication, spectrum analyzer.

I. INTRODUCTION

A satellite is basically a self-contained communication system with the ability to receive signals from earth and to retransmit those signals back with the use of a transponder which is an integrated receiver and transmitter of radio signals. A satellite has to withstand the shock of being accelerated during launch up to the orbital velocity of 28,100 km (17,500 miles) where it can be subject to radiation and extreme temperature for its projected operational life. The main components of a satellite are the communication system, power system and propulsion system. The communication system consists of antennas and transponders, the power system includes the solar panels that provide power and the propulsion system includes the rockets that propel the satellite. Launching a satellite into space requires a very powerful multistage rocket to propel it into the right Orbits. Earth stations communicate with spacecraft by transmitting and receiving radio waves in the super high frequency or extremely high frequency band. When a ground station successfully transmits radio waves to a spacecraft it establishes a telecommunication link. To measure the reliability and performance of the ground station as per the specifications and evaluating the parameters of Bangalore ground station, every system in the station is to be tested at regular interval of time to know performance of the station. To carry out the TTC functions effectively a ground station needs to be evaluated for its performance of critical parameters. The tests performed for evaluating ground station are: uplink tests,

downlink tests, servo control test and antenna radiation test.

II. GROUND STATION

The ground station acts as an interface between the satellite and satellite controllers by providing the services and functions namely telemetry, tracking and command collectively called as TTC operations.

The antennas on board the satellite serve as an interface between the earth stations on the ground and various satellite sub-systems during operations.

Antennas receive the uplink signals and transmit the downlink signals. The ground station has two S-band parabolic antennas (BLR1 and BLR2) each of 10m diameters .It can be revolved around 360 deg in horizontal plane (azimuth angle) and about 90 deg in vertical plane (elevation angle)

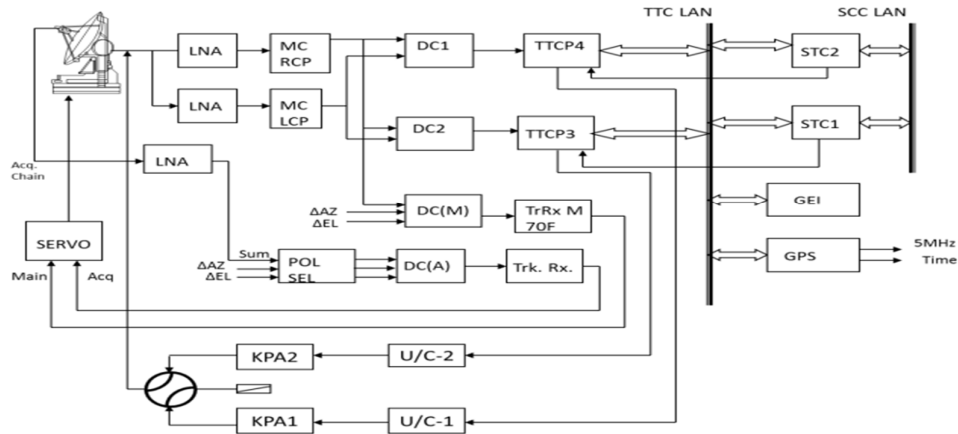

Figure 1: Block diagram of ground station

Low noise amplifier (LNA) controls noise and gives good signal quality. It is an active amplifier. It has 2.2 to 2.3 GHz in-band signal processing ability, 100MHz bandwidth and gain of 45dB. Noise temp is 150⁰K. *Multi-coupler (MC)* effectively distributes signals at high frequency levels. It isolates and distributes the signals for simultaneous or parallel reception. Frequency and Level remains unchanged. *Down converter (DC)* converts the RF signal (2.2GHz to 3GHz) to intermediate frequency (IF) of 70MHz signal using a local oscillator signal. *Up converter (UC)* converts IF signals to RF signals. *Satellite Control Centre (SCC)* located at ISTRAC is the focal point for spacecraft health monitoring control and analysis planning of all operations and network coordination. All the network stations are lined with SCC through satellite links. The functions of SCC are:

- Receiving telemetry data from network ground station.
- Determining orbital parameters from tracking data receiver.
- Commanding the satellite for spacecraft health keeping.
- Payload data operation.

III. METHODOLOGY

The ground station controls the Launch Vehicle carrying the satellite to some distance. To achieve this, all the systems of ground station must be tested and ground station has to be qualified before the start of the Launch Vehicle. The various systems of the ground station are Antenna system, Uplink system, Downlink system and Servo control system.

A. Downlink system

The communication going from a satellite to ground is called downlink system. The following tests are done to test the Downlink system:

Gain/Noise temperature measurement: It is the measure of its ability to track the weakest possible signal in a given bandwidth. The principle behind the determination of G/T is to measure the increase in Noise power, which occurs when the antenna is pointed first at the region of cold-sky and then moved to a strong source of known flux density of sun. This ratio of received power is known as the Y-factor.

$$Y = (P_{\text{sun}} / P_{\text{coldsky}})$$

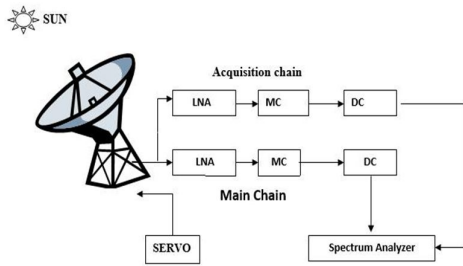

Fig 2: Test set up for Sun Measurement of G/T

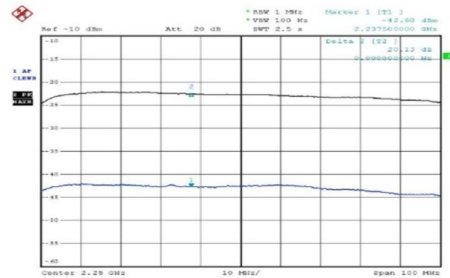

Fig 3: Plot of Y-factor.

Measurement approach:

- Tune the system to the desired frequency of operation.
- Orient the antenna towards the sun.
- Optimize the position of the antenna to obtain the maximum noise floor.
- Orient the antenna away from the sun and note down the noise floor.
- The difference between these two gives the Y-Factor.
- Calculate the G/T using the formula after obtaining the Solar Flux density.

Equation to calculate G/T value:

$$G/T = 10 \log ((8 * \pi * k * (Y-1) * K_1 * K_2) / (\lambda^2 * S))$$

Where,

K= Boltzmann Constant = $1.38 * 10^{-23}$ J/K.

K₁= Atmospheric attenuation factor.

K₂= Beam-size correction factor = $1 + 0.38(W_s / W_a)^2$

Where,

W_s= Diameter of the radio sun in degrees at f_o.

W_a= Antenna 3 dB beam-width.

λ= Wavelength of operating frequency (f_o) in meters.

S= Solar flux density measured at f_o frequency in $10^{-22} \text{W/m}^2/\text{Hz}$ for sun as celestial noise source which can be obtained from the website “gopher//solar.sec.noaa.gov”.

Result: The specified value of G/T is 21 dB/ deg. K and the value of the Y- factor should be in between 0 to 20 dB.

Receiver System Bit Error Rate(BER): It is the rate at which errors occur in a transmission system. BER is the percentage of bits that have errors relative to the total number of bits that have been transmitted or received in a given time period.

Measurement approach:

- Configure the test set up as shown in figure.
- Simulator generates a Pseudo Noise sequence which is given to the BPSK modulator and modulated.
- This signal is then modulated over 70 MHz PM and uplinked.
- Received signal is given to the DC where it is converted to downlink frequency and then demodulated.

- BER for different values of C/N_0 of sub-carrier is noted till threshold conditions.
- Estimate the threshold value of C/N_0 and verify with the observed value. The threshold value of C/N_0 can be calculated using the formulae given below:

$$C/N_0 = 10 \log (BR) + \text{Minimum } E_b/N_0 \text{ required} + \text{Modulation loss}$$

Where,

BR= Bit Rate = 1Mbps during launch time

Minimum E_b/N_0 required = 10.5 dB

Modulation loss = 4.8 dB

The modulation loss depends upon the Modulation index. The test is done at modulation index of 0.7 rad and the corresponding modulation loss is 4.8 dB.

The Threshold value of is equal to 75.3 dB.

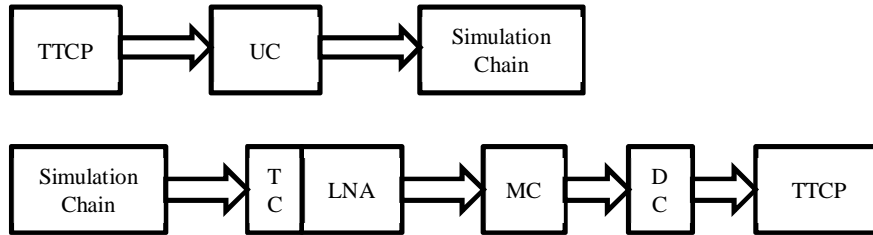
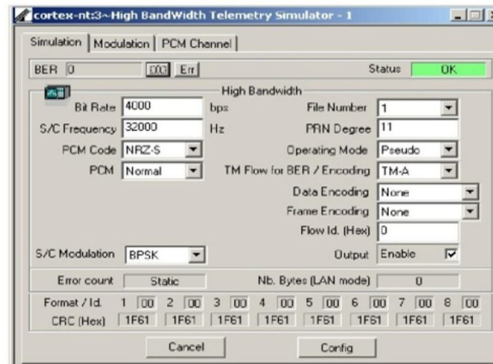

Figure4: Test set up to measure BER

TABLE I: THE BER IS ZERO AND ACCORDING TO THE SPECIFICATION THE MINIMUM VALUE OF BER IS 1×10^{-6} .



Receiver System Threshold: The minimum signal level which is required for the receiver system in order to maintain lock and to operate within its dynamic range of operation is called as Receiver System Threshold.

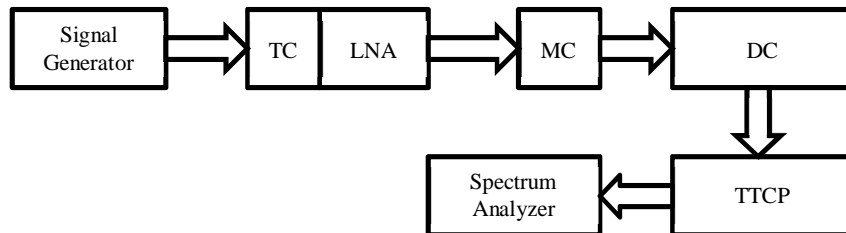

Figure 5: Test measure to set up Receiver System Threshold.

Measurement approach:

- Configure the test set up as shown in Figure.

- Vary the signal Generator level by 1dB and check every time the lock status in TTCP Receiver 1 and Receiver 2 (or the tracking receiver).
- Record the minimum signal level below which the TTCP loses lock.
- At lock threshold, both Receiver 1 and Receiver 2 of TTCP should remain in Steady lock.
- Record the observations.
- The cable connected between the signal generator and test coupler has a loss of -92 dBm.

TABLE II: THE SPECIFIED VALUE FOR THE RECEIVER SYSTEM TO MAINTAIN LOCK IS -138.00 DBM

Signal Generator Level (dBm)	Receiver 1 condition	Receiver 2 condition	LNA input= Signal Generator Level + Simulation loss (dBm)
-40.00	On	On	-132.00
-41.00	On	On	-133.20
-42.00	On	On	-134.33
-43.00	On	On	-135.45
-44.00	On	On	-136.54
-45.00	On	On	-137.62
-46.00	On	On	-138.68
-47.00	On	On	-139.78
-48.00	Off	Off	-140.00

B. Uplink System

The communication going from ground to a satellite is called uplink system. The following tests are done to test the Uplink system

Transmitter Test: Transmitter tests are carried out to calculate the following parameters

- Output power.
- Output frequency response.
- Spurious emission.
- Harmonic measurement.

Spurious emissions are transmitted signals at frequencies other than those necessary for the intended communications. The Transmitter test is carried out for both in band and out of band frequencies .Harmonic measurement is done in order to ensure that the transmitted power is very less at the Harmonics

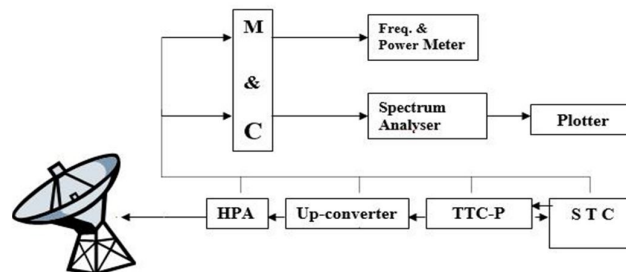

Figure 6 : Test set up for transmitter tests

Measurement approach:

- Configure the test setup as shown in the figure.
- The transmitter output power and frequency are measured by means of a power meter and frequency counter (through monitoring and control unit) connected to the test coupler at the output of transmitter.
- The transmitter output frequency response is measured by using external Network analyzer or using a signal generator in the desired band and recording the response on a spectrum analyzer and plotter through the Monitoring and control (M&C) system.
- The system spurious emission is measured by detecting any undesired output

- Frequency components in the output spectrum of the transmitter.
- Note down the readings in data sheet :

Operating frequency (MHz):2070MHz
 Instantaneous BW (MHz):95MHz
 Output power (KW):100 Watts
 Harmonic levels (dBc): -72 dBm
 Spurious level (In band- Narrow) (dBc):-70 dBc
 Spurious level(In band- wide)(dBc):-72 dBc
 Spurious level (out of band &inband) (dBc):-50dBc

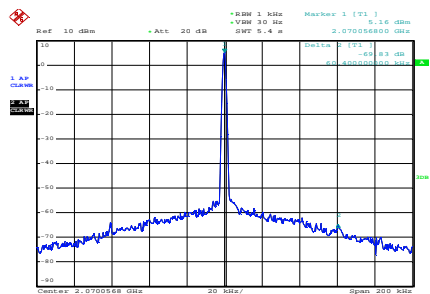

Date: 10.MAR.2017 08:58:14

Figure7: Plot showing the transmitter tests for up- link in band narrow

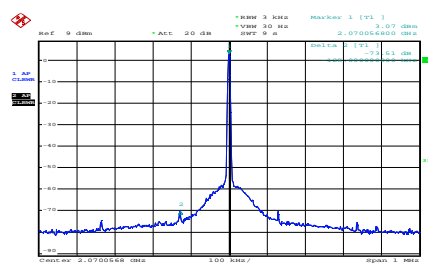

Date: 10.MAR.2017 09:07:45

Figure10: Plot showing the transmitter tests for up- link in band wide

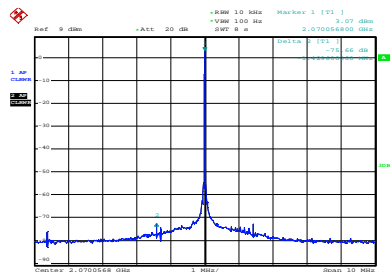

Date: 10.MAR.2017 09:07:07

Figure 8: Plot showing the transmitter tests (uplink) for wideband

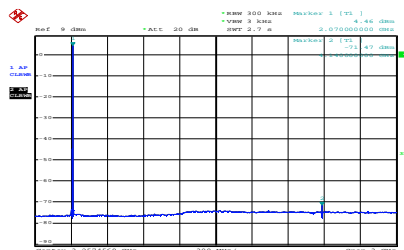

Date: 10.MAR.2017 09:16:59

Figure 11: Plot showing transmission test for harmonics

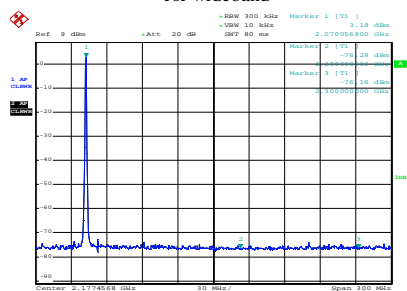

Date: 10.MAR.2017 09:12:52

Figure 9 :Plot showing the transmitter test of up-link out of band

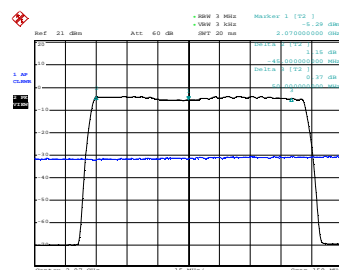

Date: 10.MAR.2017 09:28:09

Figure12: Plot showing the transmission test for bandwidth measurement

Modulation Index Measurement: Modulation index is the ratio of deviation in signal frequency to maximum baseband signal frequency. The test is carried out by measuring the modulation index against a set value of modulation index, using spectrum analyzer.

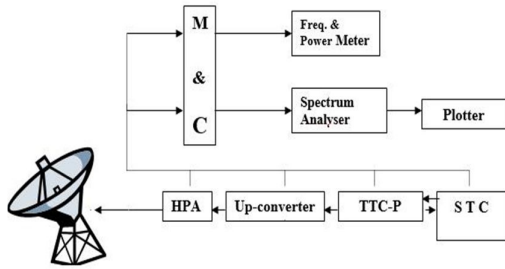

Figure13: Test set up for modulation index measurements

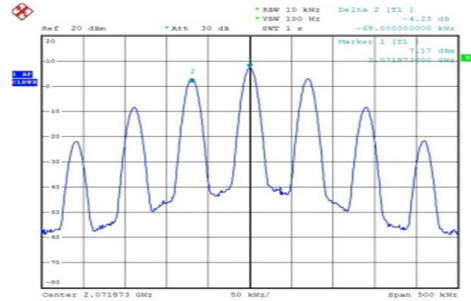

Figure 14: Plot showing modulation index measurement of an antenna

Measurement approach:

- Set the Modulation index in modulator of TTC-Processor.
- Measure the modulation index by using spectrum analyzer.
- The Uplink sweep range and sweep rate are measured by the recording the uplink frequency variation range on a spectrum analyzer and noting the time taken for completing a sweep using a stop clock.

Operating frequency (MHz): 2071.875MHz

Modulation index setting range: 0.1 to 2.0 Radian

SI.NO	Modulation index setting	(J1/J0) dB	Measured (J1/J0)
1.	0.7 Rad	-8.55	-8.56
2.	1.0 Rad	-4.80	-4.78
3.	1.05 Rad	-4.23	-4.18

Effective Isotropic Radiated Pattern: The Effective Isotropic Radiated Power(EIRP) of a transmitter (uplink) is the power that the transmitter appears to have if the transmitter is behaving like an isotropic radiator, i.e., if it radiated equally in all directions. EIRP is the figure of merit of the transmitter system. The EIRP is given by the product of the gain and the transmitter power. The output power of the Transmitter is measured with the help of the power meter.

Measurement approach:

- Follow the standard procedure of switching on the servo system.
- Switch on the bore sight. set appropriate power level and frequency in the bore sight source if test is to be carried out at bore sight.
- Orient the antenna to bore sight or GSM in manual mode and maximize the signal.
- Click settings and click on test and evaluation function.
- Select S curve test. Window will appear with AZ/EL present angles,+/- angle sweep required, AZ, EL selection.
- Click on test button. Enter file name for ex. S-curve AZ. Press enter. After the test plot the graph of AZ error.
- Repeat the same procedure for EL. Save file with S curve EL. Plot the graph.

Result:

Effective Isotropic Radiated Power = $P_t - L_w + G_t$

where,

P_t = Transmitter Output Power = 33dBW.

L_w = Loss between the transmitter and the transmit feed = 2dB.

G_t = Gain of the ground station antenna at transmit frequency = 43

Effective Isotropic Radiated Power = $P_t - L_w + G_t = 74$ dBW.

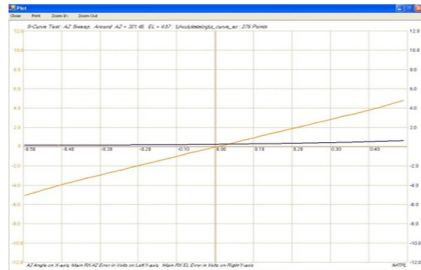

Figure 15: Plot showing the error sensitivity (S-Curve) for azimuth angle

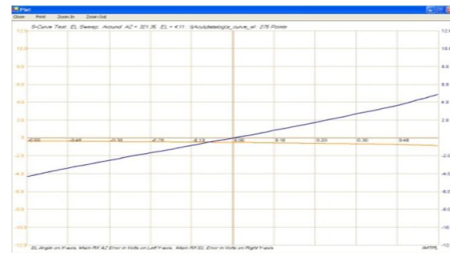

Figure 16: Plot showing the error sensitivity (S-Curve) for elevation angle

C. Antenna Radiation Pattern

Radiation pattern of an antenna is a graph, which shows the variation of actual field at all points, which are at equal distances from the antenna. Receive radiation pattern of Antenna is the directional sensitivity for Power flux density of the radiated field. Sun or Bore sight can be employed as targets to determine and plot receive radiation pattern. GMS satellite (Geo-Synchronous satellite) is used as target in order to plot the radiation pattern of the antenna.

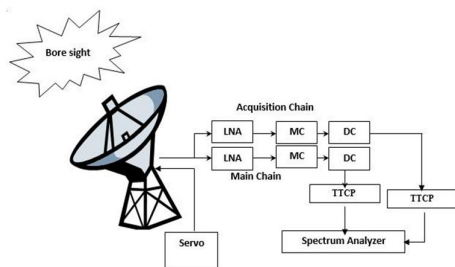

Figure 17: Test set up for radiation pattern

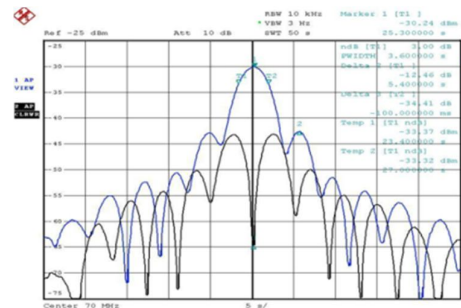

Figure 18: Plot of radiation pattern

The Radiation Pattern can be plotted in the Spectrum Analyzer after adjusting the sweep time in order to plot the entire received signal strength from the GMS satellite when the antenna is rotating in azimuth axis or elevation axis.

Measurement approach:

- Orient the antenna towards GMS satellite.
- Optimize the position of the antenna for obtaining the maximum signal strength in particular polarization.
- Position and rotate the antenna in azimuth or elevation axis by $\pm 5^\circ$ at a constant speed.
- The radiation pattern is plotted with the help of spectrum analyzer.
- The 3dB points are determined from which the beam width of the antenna can be calculated.
- The null depth can also be determined from radiation pattern by plotting the error signal received by the antenna.

Result:

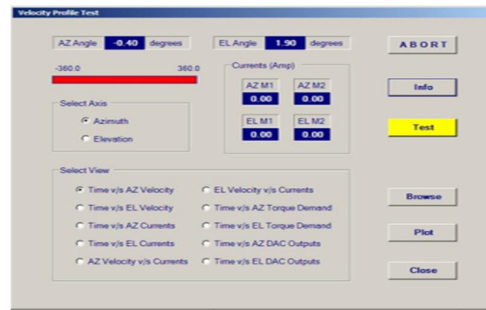

D. Servo Control System

It is used to control the antenna rotation. It can be operated in several mode such as slew, main, auto, manual, program, and slave modes. Various built-in tests are provided to check system capability .Programming parameters like velocity and angles are fixed. Servo system measurements is done in two ways:

- a) Velocity test
- b) Acceleration test

With these tests we check the system performance at 1deg/sec speed to 9 deg/sec speed. Plotting facility is provided to plot the graphs.

Velocity Test: The Velocity test is done in order to check the Servo system performance. This test will move the antenna with programmed velocities .Initially antenna will move with 1deg/sec velocity in CW and CCW direction. After this move antenna will move with 5deg/sec velocity in CW and CCW direction and then with 9deg/sec in both directions. This test is done by setting to velocity Profile Test in TTCP.

Measurement approach:

- Select Settings mode in TTCP.
- Select Test and Evaluation option .
- Select Velocity Profile Test option.
- Set the initial azimuth and elevation angles.
- Select azimuth or elevation to conduct test.

Click on the Test option.

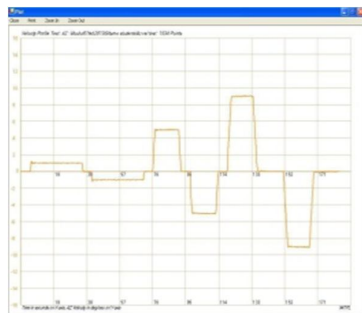

Figure 19: Plot of azimuth angle

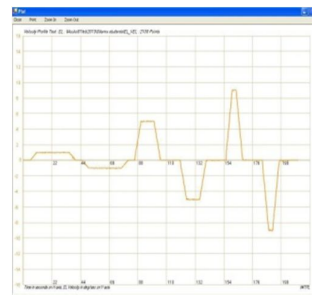

Figure 20: Plot of elevation angle

Acceleration Test: Acceleration test is done to check the maximum acceleration of the Servo system .

Maximum acceleration of the system according to the specifications is 3deg/sec².Acceleration test is done by changing the settings in the TTCP and the results can be observed in the TTCP.

Measurement approach:

- Select settings mode in TTCP.
- Select Test and Evaluation option .
- Select Velocity Profile Test option.
- Set the initial azimuth and elevation angles.
- Select azimuth or elevation to conduct test.
- Click on the Test option.

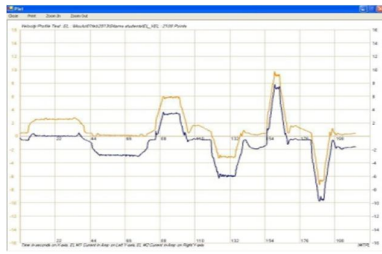

Figure 21: Plot of elevation motor currents

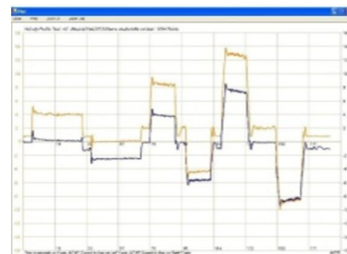

Figure 22: Plot of azimuth motor currents

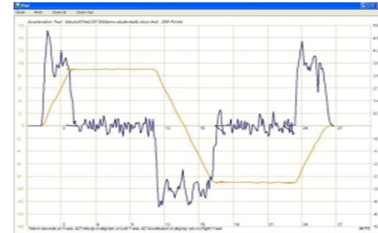
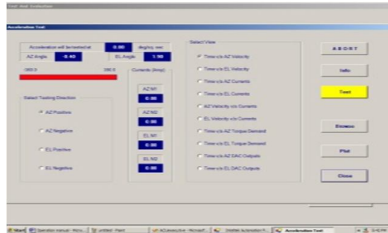

Fig23: Plot of acceleration test

IV. CONCLUSION

The area of satellite communication has spread its wings over a wide range of application. This work was an attempt to understand the various nuances involved in telemetry, tracking and command of IRS satellites. Through the process, it is evident that some parameters are very inevitable to decide the performance of the ground station and its credibility to support TTC operations in interplanetary missions. Measurements like G/T, radiation pattern, AGC, BER, receive system threshold, modulation index, transmitter-tests, ranging and Doppler tests and servo system tests were recorded to verify the performance of the ground station and these values were compared with the station specification. Observations made determined that the Bangalore Ground Station is appropriate to perform TTC operation for satellites and interplanetary mission. Periodical tracking of satellite's position aided in effective communication with the satellite. One important aspect of research is the scaling of system in order to match the requirements of the satellite.

ACKNOWLEDGEMENT

This work is carried out at ISTRAC (ISRO Telemetry, Tracking and Command), under the guidance of Manjunath. K, Engr-SE, IBDF/GSNA, ISTRAC/ISRO. We thank Department of Electronics & Communication Engineering, JSS Academy of Technical Education, Bangalore, for constant encouragement.

REFERENCES

- [1] Dr. D. C. Agarwal, "Satellite Communications", 5th Edition, Khanna Publications.
- [2] Simon Haykins, "Digital Communications", 2nd Edition, Wiley and Sons.
- [3] Arthur Norman Guest, "Telemetry, Tracking and Command", 2nd Edition-2013.
- [4] David Hart, "Satellite Communications", paper May 1997
- [5] www.engineerblogs.net/other.../satellite-communications-and- navigation/
- [6] Dennis Roddy, "Satellite Communication", 3rd Edition, McGraw Hill-2001.
- [7] Khalid S. Khan, "Tracking techniques for inclined orbit satellites", IEEE paper July 10, 1990, www.ieeexplore.info/serach/searchresults.jsp?...QT.Khan%2C+K...
- [8] ISRO, "ISTRAC Ground Station Manual", NOV 28, 2013.
- [9] Joseph H. Reisert, "Understanding and Using Antenna Radiation Patterns", May 16, 2011, www.astrinwireless.com/topic-archives-antenna-radiation-patterns.asp...